



Technical Data Sheet

0.39" Single Digit SMD Displays

ELSS-405SYGWA/S530-E2

Features

- Packaged in tape and reel for SMT manufacturing.
- Design flexibility(common cathode or anode).
- Categorized for luminous intensity.
- The thickness is thinner than tradition display.
- Pb free
- The product itself will remain with RoHS compliant version.

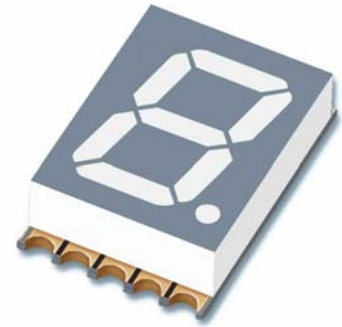

Descriptions

- The SMD type is much smaller than tradition type components, thus enable smaller board size, higher packing density, reduced storage space and finally smaller equipment to be obtained.

Applications

- Suitable for indoor use.
- Audio system.
- Set top box.
- Game machine.
- Channel indicator of TV.

Device Selection Guide

Chip		Face Color
Material	Emitted Color	
AlGaInP	Brilliant Yellow Green	Gray

Package Dimensions

Land Pattern(Recommend)

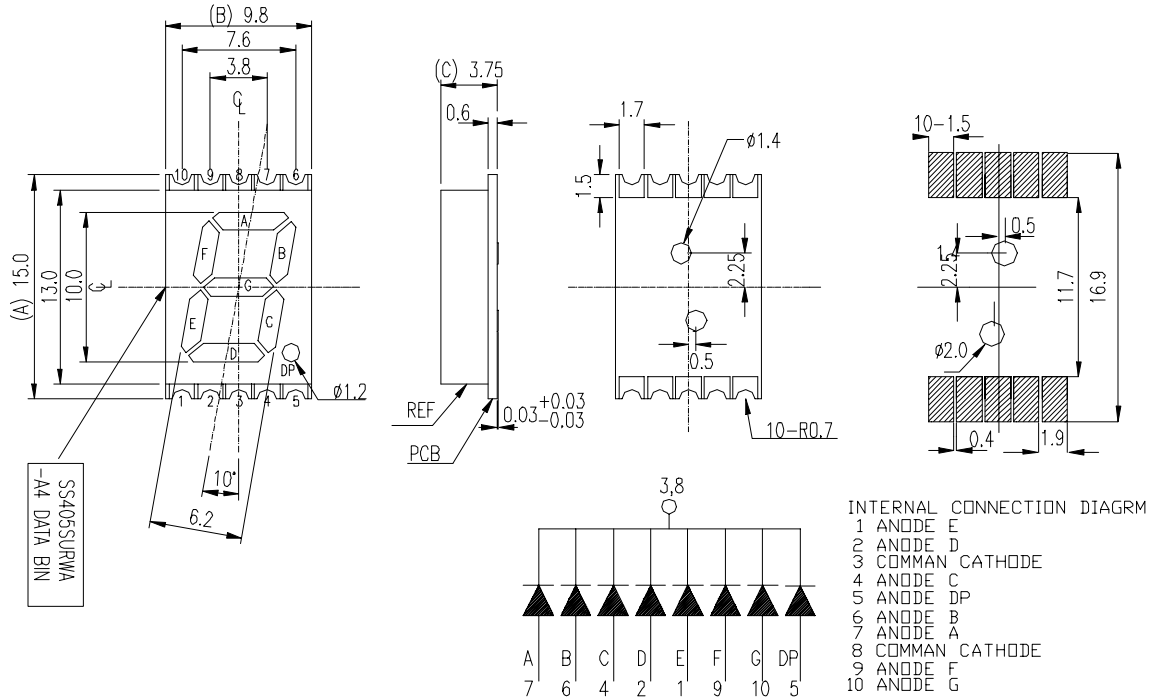

Notes:

- All dimensions are in millimeters, tolerance is 0.25mm unless otherwise noted.
- Above specification may be changed without notice. Supplier will reserve authority on material change for above specification.

Absolute Maximum Ratings (Ta=25°C)

Parameter	Symbol	Rating	Units
Forward Current	I _F	25	mA
Pulse Forward Current ^{*1}	I _{FP}	60	mA
Operating Temperature	T _{opr}	-40 ~ +85	°C
Storage Temperature	T _{stg}	-40 ~ +85	°C
Reflow Temperature ^{*2}	T _{ref}	260	°C
Electrostatic Discharge	ESD	2000	V
Power Dissipation	P _d	60	mW
Reverse Voltage	V _R	5	V

Notes: *1:I_{FP} Conditions--Pulse Width ≤ 10msec and Duty ≤ 1/10.

*2:Reflow time ≤ 5 seconds.

Electro-Optical Characteristics (Ta=25°C)

Parameter		Symbol	Min.	Typ.	Max.	Units	Condition
Forward Voltage		V_F	--	2.1	2.4	V	$I_F=20mA$
Reverse Current		I_R	--	--	10	μA	$V_R=5V$
Luminous Intensity	Per segment	I_V	4.0	10.6	--	mcd	$I_F=10mA$
	Per decimal point		2.0	3.7	--		
Peak Wavelength		λ_p	--	575	--	nm	$I_F=20mA$
Dominant Wavelength		λ_d	--	573	--	nm	$I_F=20mA$
Spectrum Radiation Bandwidth		$\Delta \lambda$	--	20	--	nm	$I_F=20mA$

Chromaticity Coordinates Specifications for Bin Grading (Unit: mcd)

Rank	Min.	Max.	Rank	Min.	Max.
N	4.0	6.4	T	21.0	34.0
P	5.6	8.9	U	30.0	48.0
Q	7.8	12.5	V	42.0	67.0
R	11.0	17.6	W	59.0	94.0
S	15.0	24.0	---	---	---

Typical Electro-Optical Characteristics Curves

(SYG)

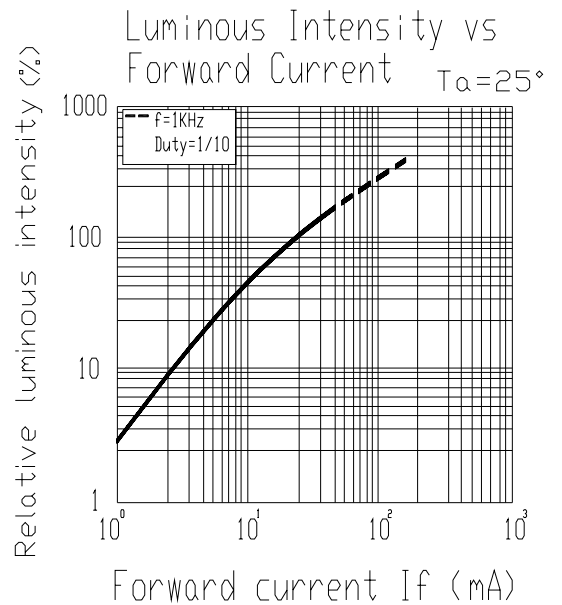
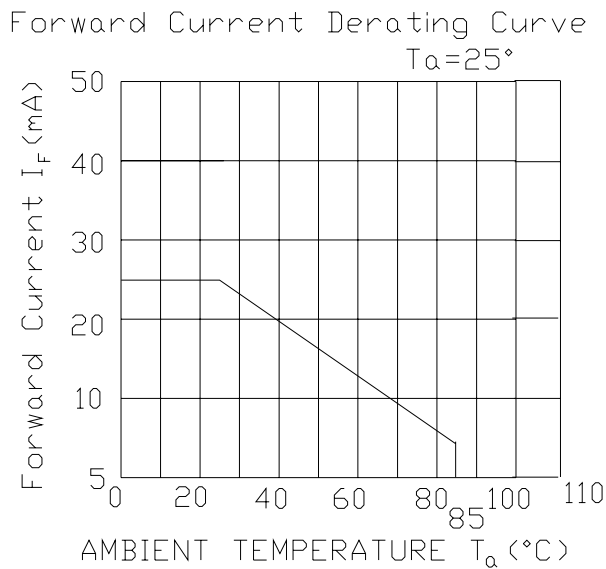
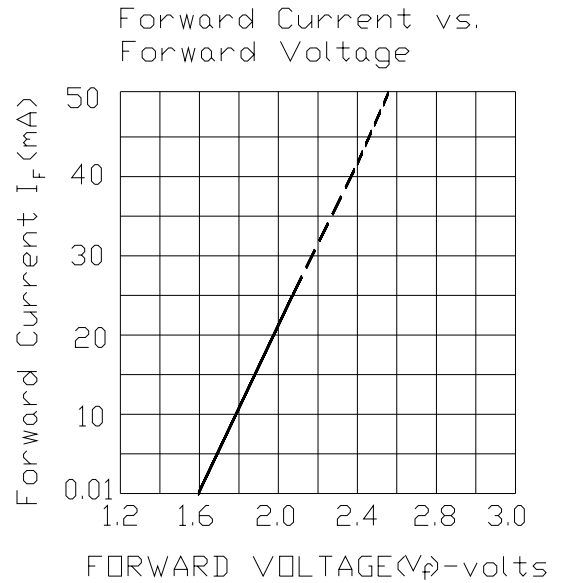
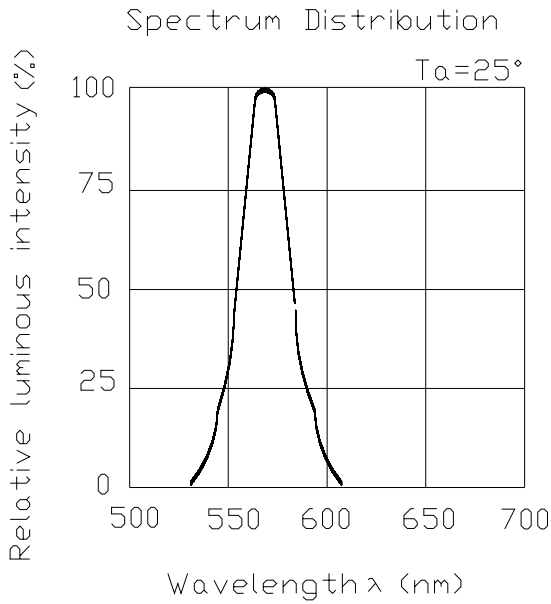

■ **Reflow Temp. / Time :**

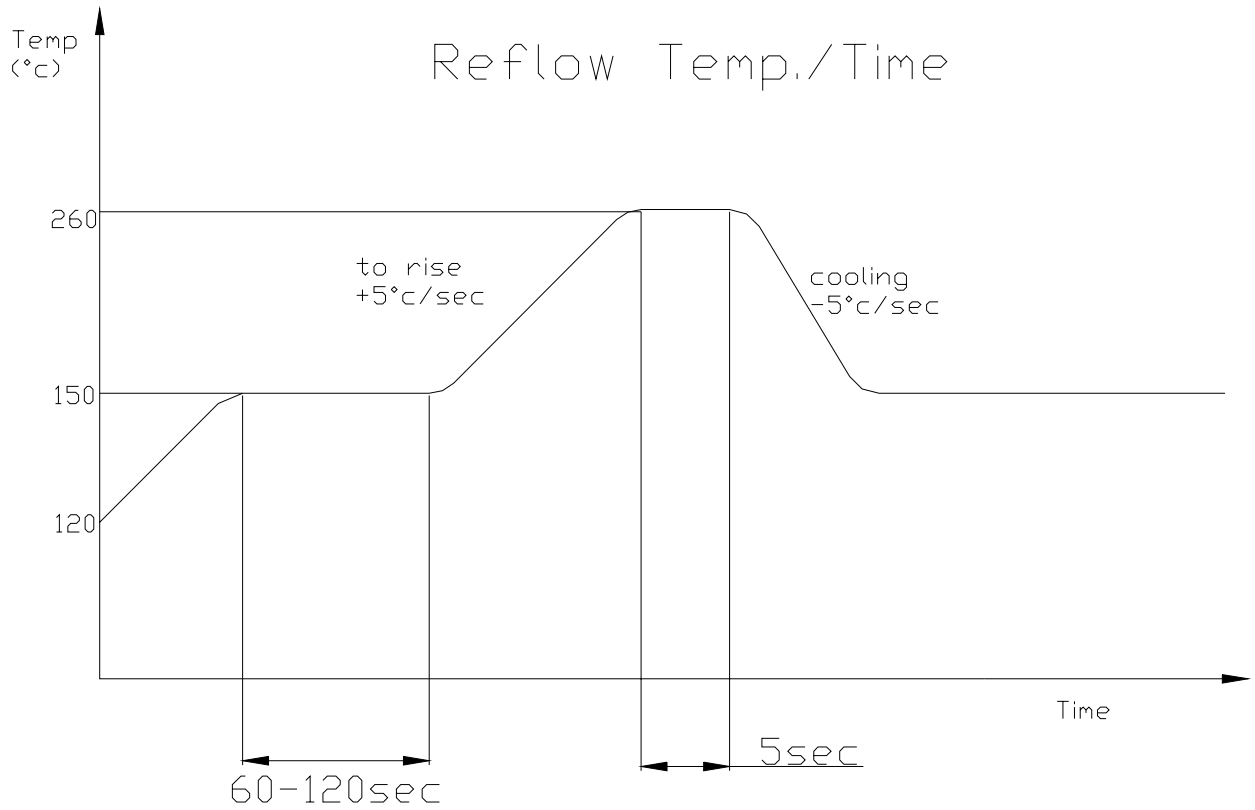

■ **Soldering Iron :**

Basic spec is ≤ 5 sec when 260°C . If temperature is higher, time should be shorter ($+10^{\circ}\text{C} \rightarrow -1\text{sec}$). Power dissipation of iron should be smaller than 15 W , and temperature should be controllable. Surface temperature of the device should be under 230°C .

■ **Rework :**

1. Customer must finish rework within 5 sec under 260°C .
2. The head of iron can not touch copper foil.